



- PIN Access
- Mechanical Pushbutton Lock
- Single Access Code
- Cylindrical and Exit Trim
- Lever/Knob
- ANSI/BHMA Grade-1 Certified

### Features

<b>Access Control:</b>	Mechanical pushbutton lock—eliminates problems and costs associated with issuing, controlling, and collecting keys and cards. Provides exterior access by combination, while allowing free egress.		
<b>No Battery:</b>	Fully mechanical lock eliminates the material and labor expense of battery replacements		
<b>Locking Device Options:</b>	<p><u>Cylindrical</u>: Cylindrical latch with 3 hour UL/ULC fire rating on “A” labeled doors</p> <p><u>Rim Exit Device</u>: Compatible with most leading brands of exit devices (exit device and mounting hardware not included)</p> <p>Universal mounting plate (included) simplifies installation and eliminates any requirement to stock different locks/plates for various exit devices</p>		
<b>Exit Device Compatibility:</b>	Arrow S1250	Monarch 18R/F-18R	Sargent 8888
	Arrow S3800	Precision 21/FL 21	Von Duprin 22/22F
	Corbin Russwin 5200/5200A	Sargent 2828	Von Duprin 98/98F
	Detex 10/F10	Sargent 3828	Von Duprin 99/99F
	Dorma 9300/9300F	Sargent 8800	Yale 7100
	<p>• <b>Cannot be used with mortise design or most vertical rod Exit Devices</b></p> <p><b>ATTENTION: Compatibility is subject to change if modifications are made by Exit Device manufacturers without Kaba Access Control's knowledge</b></p>		
<b>Number of Codes:</b>	Single access code—one easy to manage code for all users		
<b>Programming:</b>	Lock is easily programmed via keypad without removing lock from the door		
<b>Handing:</b>	Non-handed, pre-assembled for left-hand door installations—easily changed in the field		
<b>Key Override:</b>	Key-in-lever cylinders, small format interchangeable cores, and large format removable cores		
<b>Operation Modes:</b>	<p>Single credential—access</p> <p>Passage (select models)—Allows access without using the lock entry code. Feature activated from the inside with a thumbturn or key (included with all passage feature models)</p> <p>Exit trim may be “dogged” if exit device allows</p>		
<b>Direct Drive Design:</b>	Clutch free design—minimizes friction and wear		
<b>Economical:</b>	A cost effective access control solution		

**Mechanical Features**

<b>Construction:</b>	Extra heavy-duty, solid cast housings, solid cast levers, and wear tested for extensive use in indoor and outdoor applications
<b>Numeric Keypad:</b>	Vandal resistant, solid metal pushbuttons
<b>Handing:</b>	Non-handed, pre-assembled for left-hand door installations—easily changed in the field
<b>Standard Finishes:</b>	Satin Chrome 26D (626) housings and levers Black 676 housings with Satin Chrome 26D (626) levers and accents
<b>Optional Finishes:</b>	Bright Brass 03 (605) housings and levers Bright Chrome 026 (625) housings and levers Dark Bronze 744 housings and levers with Brass accents Satin Brass 04 (606) housings and levers
<b>Backset:</b>	<u>Cylindrical:</u> 2¾" (70 mm) backset, 2 ⅜" (60 mm) backset <u>Exit Device:</u> varies by exit device
<b>Latch:</b>	½" (13 mm) latch, ¾" (19 mm) latch (optional)
<b>Minimum Stile Recommended:</b>	5" (127 mm)
<b>Weight:</b>	<u>Cylindrical:</u> 9 lbs. (4.08 kg) <u>Exit Device:</u> 8 lbs (3.63 kg)

**Key Override**

<b>Universal Key-In-Lever Cylinders:</b>	Includes Kaba 1599 6-pin cylinder (prepped to Kaba 90 or Schlage "C" Keyway, keyed different) and tailpieces for compatibility with:																		
	<table border="0"> <tr> <td>Abloy 5277</td> <td>Kaba Peaks 1099</td> </tr> <tr> <td>Abloy 5477</td> <td>Marks</td> </tr> <tr> <td>Arrow C 100</td> <td>Medeco 20W200H1</td> </tr> <tr> <td>ASSA 65611</td> <td>Sargent 10 Line</td> </tr> <tr> <td>ASSA 65691</td> <td>Schlage 23-001</td> </tr> <tr> <td>Corbin Russwin 2000-03</td> <td>Schlage Primus 20-760</td> </tr> <tr> <td>Kaba 1539</td> <td>Australian: Kaba expert 107K5 and Boyd KC286</td> </tr> <tr> <td>Kaba 1599</td> <td>European: Quattro S/Expert an AP2 (5 and 6-pin)</td> </tr> <tr> <td>Kaba Gemini 4730</td> <td></td> </tr> </table>	Abloy 5277	Kaba Peaks 1099	Abloy 5477	Marks	Arrow C 100	Medeco 20W200H1	ASSA 65611	Sargent 10 Line	ASSA 65691	Schlage 23-001	Corbin Russwin 2000-03	Schlage Primus 20-760	Kaba 1539	Australian: Kaba expert 107K5 and Boyd KC286	Kaba 1599	European: Quattro S/Expert an AP2 (5 and 6-pin)	Kaba Gemini 4730	
Abloy 5277	Kaba Peaks 1099																		
Abloy 5477	Marks																		
Arrow C 100	Medeco 20W200H1																		
ASSA 65611	Sargent 10 Line																		
ASSA 65691	Schlage 23-001																		
Corbin Russwin 2000-03	Schlage Primus 20-760																		
Kaba 1539	Australian: Kaba expert 107K5 and Boyd KC286																		
Kaba 1599	European: Quattro S/Expert an AP2 (5 and 6-pin)																		
Kaba Gemini 4730																			

<b>Interchangeable Cores:</b>	Small format—Best and equivalents (6 or 7-pin length)
<b>Removable Cores:</b>	Large format—Medeco/ASSA/Yale (5 or 6-pin), Corbin Russwin, Schlage, and Sargent

**Installation**

<b>Door Preparation:</b>	Easily installs on wood or metal doors. ASA 161 door preparation with additional through holes
<b>Door Thickness:</b>	<u>Cylindrical:</u> 1 ⅜" (35 mm) to 2 ¼" (57 mm). Pre-assembled to accommodate doors 1 ⅝" (41 mm) to 2" (51 mm) <u>Exit Trim:</u> 1 ¾" (44 mm) to 2 ¼" (57 mm). Pre-assembled to accommodate doors 1 ¾" (44 mm) to 2 ⅝" (54 mm)
<b>Items Supplied Include:</b>	Lock assembly, installation manual, full scale template and required installation hardware
<b>Additional Items Supplied With Key-in-Lever Cylinder model only:</b>	Universal Kaba high security 1599 6-pin cylinder with tailpiece, and two nickel silver keys

### Certification and Testing

<b>Accessibility Standard:</b>	Americans with Disabilities Act (ADA)
<b>Durability:</b>	ANSI/BHMA Grade 1 Certified, A156.2; weather resistant, wear tested for extensive use in indoor and outdoor applications
<b>Fire Rating:</b>	3-hour UL/ULC fire rating for "A" label doors

### Warranty

<b>Warranty:</b>	3-year warranty
------------------	-----------------

### Cylindrical

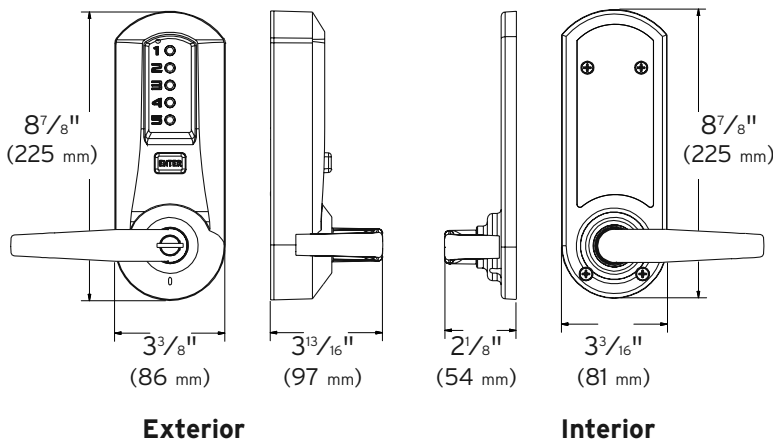

#### Model 5021

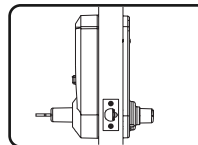

- Combination Entry
- Key Override
- Exterior Combination Change
- Knob Available

#### Model 5031

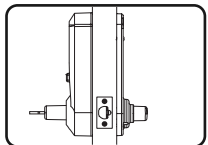

- Combination Entry
- Key Override
- Interior Combination Change, DOD Compliant
- Knob Available

#### Model 5041

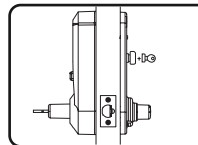

- Combination Entry
- Key Override
- Exterior Combination Change
- Passage
- Knob Available

#### Model 5051

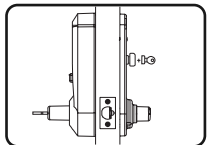

- Combination Entry
- Key Override
- Interior Combination Change, DOD Compliant, Passage
- Knob Available

### Exit Trim

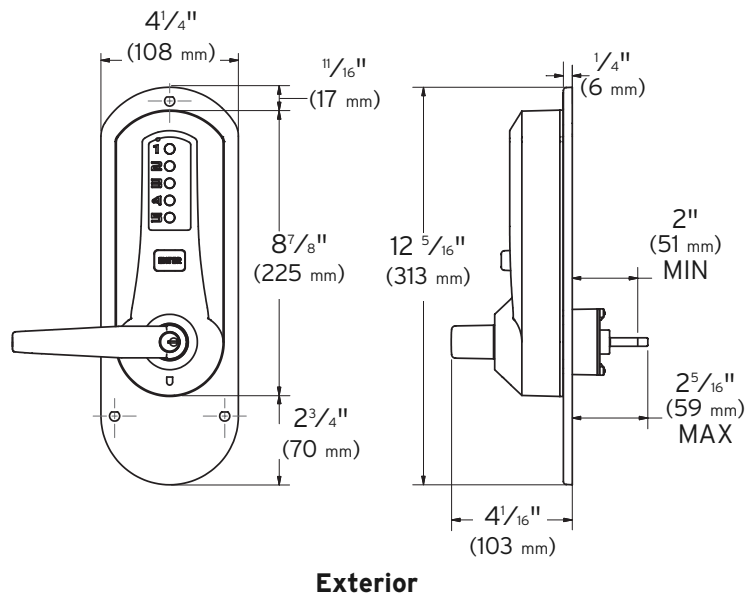

#### Model 5010

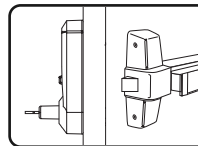

- Combination Entry
- Key Override
- Exterior Combination Change (only)
- Egress with Exit Device (Not Supplied)

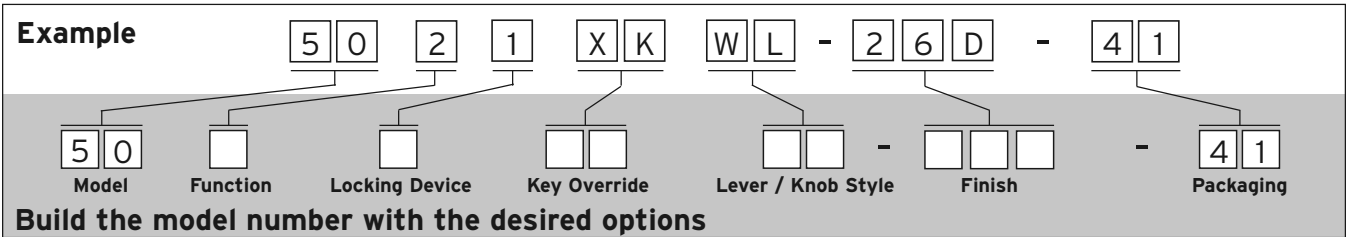

Base Model	Description
5021XKWL26D41	Cylindrical Lock with Lever, Key-in-Lever Cylinder

Key Override Options++	Description
XK	K-I-L Kaba Cylinder (Kaba 90 keyway) Included
XS	K-I-L Kaba Cylinder (Schlage "C" Keyway) Included
B	I/C Best and Equivalents (6 or 7-pin Length)
C	R/C Corbin Russwin
M	R/C Medeco/ASSA/Yale (5 or 6-pin)
R	R/C Sargent
S	R/C Schlage

### Choose one option from each category

Function Options	Description
1+	Exit Trim (E.T.)
2	Cylindrical Lock
3	Cylindrical Lock <ul style="list-style-type: none"> <li>• Interior Combination Change</li> <li>• D.O.D. Compliant</li> </ul>
4	Cylindrical Lock <ul style="list-style-type: none"> <li>• Passage</li> </ul>
5	Cylindrical Lock <ul style="list-style-type: none"> <li>• Passage</li> <li>• Interior Combination Change</li> <li>• D.O.D. Compliant</li> </ul>

Lever/Knob Options	Description
WL	Winston Lever
WK	Winston Knob (Cylindrical Locks Only)

Locking Device Options	Description
0+	Exit Trim (available with E.T. only)
1	Cylindrical ½" (13 mm) throw latch, floating face plate, 2¾" (70 mm) backset (UL listed)
2	Cylindrical ½" (13 mm) throw latch, floating face plate, 2⅝" (60 mm) backset (UL listed)
5	Cylindrical ¾" (19 mm) throw latch, beveled face plate, 2¾" (70 mm) backset (UL listed)

Finish Options	Description
026	Bright Chrome (625)
03	Bright Brass (605)
04	Satin Brass (606)
26D	Satin Chrome (626)
676	Black with Satin Chrome Accents
744	Dark Bronze with Brass Accents (simulated 10B/613)

### Notes

Exit Device Compatibility	Arrow S1250	Arrow S3800	Corbin Russwin 5200/5200A	Detex 10/F10	Dorma 9300/9300F	Monarch 18R/F-18R	Precision 21/FL 21	Sargent 2828	Sargent 3828	Sargent 8800	Sargent 8888	Von Duprin 22/22F	Von Duprin 98/98F	Von Duprin 99/99F	Yale 7100
<ul style="list-style-type: none"> <li>• Cannot be used with Mortise design or most vertical rod Exit Devices</li> </ul>															

**ATTENTION: Compatibility is subject to change if modifications are made by Exit Device manufacturers without Kaba Access Control's knowledge**

++ Interchangeable/Removable core cylinders are not included with the lock Exit Device (not included)

### Simplex® 2015 Series

Model	Description
54266	Blank Keys
54266-1-11	Master Keys for key override models. (Old #54266-1) (Specify Keycut)
54266-2-11	Service Keys for override models. (Old #54266-2) (Specify Keycut)

### Simplex® 6200 Series

Model	Description
55072-03-01	Filler Plate—Bright Brass
55072-26D-01	Filler Plate—Satin Chrome
55072-19-01	Filler Plate—Black

### Simplex® 900 Series

Model	Description
800-04-41	Adapter kit for doors with metal frames. Includes riser plates and surface mounted strike. Finish 04 Satin Brass; packaged 1 per box. (Old #74464/74468)
800-26D-41	Adapter kit for doors with metal frames. Includes riser plates and surface mounted strike. Finish 26D Satin Chrome; packaged 1 per box. (Old #74464/74468)
805-26D-41	Face plate shield. Not for use with key override models. Inhibits unauthorized observation of the combination. Finish 26D Satin Chrome; packaged 1 per box. (Old #24081-000-01)
54266	Blank Keys
54266-1-11	Master Keys for key override models. (Old #54266-1) (Specify Keycut)
54266-2-11	Service Keys for key override models (Old # 54266-2) (Specify Keycut)

### Simplex® 1000, L1000 & 5000 Cores & Wrap Plates

Model	Description
204231-03-41	Wrap Plate, 10 ½" (267 mm), Bright Brass (605)
204231-05-41	Wrap Plate, 10 ½" (267 mm), Antique Brass (609)
204231-26D-41	Wrap Plate, 10 ½" (267 mm), Satin Chrome (626)
204232-03-41	Wrap Plate, 15" (381 mm), Bright Brass (605)

204232-05-41	Wrap Plate, 15" (381 mm), Antique Brass (609)
204232-26D-41	Wrap Plate, 15" (381 mm), Satin Chrome (626)
20484-03-01	Best Equivalent SFIC Bright Brass (605)
201484-05-01	Best Equivalent SFIC Satin Brass (609)
201484-26D-01	Best Equivalent SFIC Satin Chrome (626)
201600-083-01	Anti-Spy Shield (1000/L1000 Models Only)
204022-000-01	Latch Extension Assembly converts to 3¾" (10 cm) Backset
204023-000-01	Latch Extension Assembly converts to 5" (13 cm) Backset
54644-000-41	Weather Cover (smoke colored)
64754-000-01	Lubriplate Aero Grease Tubes (1.75 oz tubes) 150°F to -70°F (66°C to -57°C)
64684-26D-01	Installation Jig (1000/L1000/5000/E5000)

### Simplex® Mounts\*

Model	Description
204246-000-41	<b>LD Series—450 &amp; 470</b> Dual Mount
04083-000-41	<b>8100</b> Series
204086-000-41	<b>EE1000</b> Series
204087-000-41	<b>LP1000</b> Series
203053-000-41	<b>900</b> Series— <b>904 &amp; 919</b> Dual Mount
204189-000-41	<b>7100</b> Series— <b>7108 &amp; 7104</b> Dual Mount
204092-000-41	<b>7100</b> Series—( <b>7106</b> Series Only)
204094-000-41	<b>6200</b> Series
204096-000-41	<b>2015</b> Series
203044-000-41	<b>1000, L1000, 5000</b> Series
74378-CH	<b>3000</b> Series Narrow Stile
SP5000 ACLMT	Simplex <b>5000</b> Acrylic Mount

\* Mounts do not include locks

Hardwood product demonstration mount, packaged 1 per box.